

PAPER • OPEN ACCESS

## Smart Solar Micro-exchangers for Sustainable Mobility of University Camps

To cite this article: Carlos Rosa-Jiménez *et al* 2020 *IOP Conf. Ser.: Mater. Sci. Eng.* **960** 042011

View the [article online](#) for updates and enhancements.

You may also like

- [LOCALIZATION AND BROADBAND FOLLOW-UP OF THE GRAVITATIONAL-WAVE TRANSIENT GW150914](#)  
B. P. Abbott, R. Abbott, T. D. Abbott et al.
- [SUPPLEMENT: "LOCALIZATION AND BROADBAND FOLLOW-UP OF THE GRAVITATIONAL-WAVE TRANSIENT GW150914" \(2016, ApJL, 826, L13\)](#)  
B. P. Abbott, R. Abbott, T. D. Abbott et al.
- [Indicator System to Measure the Qualities of Urban Space Affecting Urban Safety and Coexistence](#)  
Nuria Nebot Gómez de Salazar, Marta Cornax Martín, Francisco J. Chamizo Nieto et al.

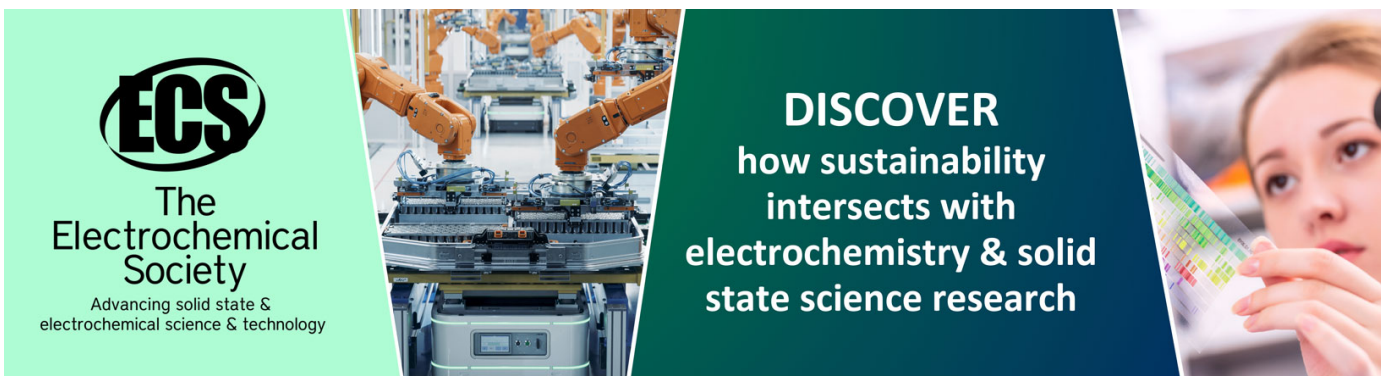

**ECS**  
The  
Electrochemical  
Society  
Advancing solid state &  
electrochemical science & technology

**DISCOVER**  
how sustainability  
intersects with  
electrochemistry & solid  
state science research

# Smart Solar Micro-exchangers for Sustainable Mobility of University Camps

**Carlos Rosa-Jiménez<sup>1</sup>, Isabel de-la-Bandera<sup>2</sup>, Llanos Mora-López<sup>3</sup>, Mariano Sidrach-de-Cardona<sup>4</sup>, Antonio Álvarez-Gil<sup>1</sup>, Lourdes Camacho-Mérida<sup>2</sup>, Inmaculada Casauco-Tenllado<sup>4</sup>, Samuel Delgado-Fernández<sup>3</sup>, Alberto E. García-Moreno<sup>1</sup>, Maria J. Márquez-Ballesteros<sup>1</sup>, Jessica Mendoza Ruiz<sup>2</sup>, Alejandro Morales-Martín<sup>1</sup>, Nuria Nebot<sup>1</sup>, Jose Carlos Baena-González<sup>2</sup>, Ferrán Ventura-Blanch<sup>1</sup>, Jesús Vías-Martínez<sup>5</sup>**

<sup>1</sup>E.T.S. Arquitectura, University of Malaga, Campus de El Ejido, 29071 Málaga, Spain

<sup>2</sup>E.T.S. Ingeniería de Telecomunicaciones, University of Malaga, Campus de Teatinos, 29071 Málaga, Spain

<sup>3</sup>E.T.S. Ingeniería Informática, University of Malaga, Campus de Teatinos, 29071 Málaga, Spain

<sup>4</sup>Escuelas de Ingenierías Industriales, University of Malaga, Campus de Teatinos, 29071 Málaga, Spain

<sup>5</sup>Facultad de Geografía, Universidad de Málaga, Campus de Teatinos, 29071 Málaga, Spain

cjrosa@uma.es

**Abstract.** A significant number of universities have several campuses located in urban or rural settings, or with scattered university buildings that require the use of means of transportation. This implies the mobility and potential displacement of a large community of students, professors and researchers. The use of electric bicycles (e-bikes) is an intermediate alternative between the bicycle and electric cars. It can be an important stimulus for the promotion of the decarbonisation of the University Campus, avoiding the traffic congestion and reducing space requirements for parking. This paper presents the smart solar micro-exchanger model managed through a sustainable mobility web platform, applied to the case study of the University of Malaga (Spain). It is a solar charging station for e-bike, whose design is based on the principles of solar architecture (providing great security to e-bike). It managed by a web platform and app that allows the user to make reservations and learn about the savings in CO<sub>2</sub> emissions. The system allows performing an aerobic sports activity without sweating problems when you reach the job. The platform also incorporates a database of quiet and safe routes for e-bike users.

## 1. Introduction

The mobility model is one of the university activity variables that most compromises the university's objective of both improving the quality of life and guaranteeing the balance of its activity with environmental sustainability, social cohesion and economic efficiency [1]. University mobility has a high the dependence on the car for its speed and the underuse of public transport due to its low frequency; low speed and low adequate stop structure [2] [3]. Among the main mobility problems that must be faced are: (a) The existence of several campuses with different locations in the urban and / or



rural environment, which increases the displacement of a large community of students, teachers and researchers; (b) the problems of traffic jams due to the predominance of automobile use at their accesses [4]; and the lack of parking on university campuses located in historic centers that also have new regulations that limit access to motorized vehicles that emit CO<sub>2</sub>.

To improve sustainable mobility in the university population, this paper presents the smart solar micro-exchanger (SSM) for electric bicycles (e-bikes) managed through a sustainable mobility web platform. The SSM responds on a small scale to two sustainable mobility strategies: the creation of islands of pedestrian mobility and modal exchange nodes to connect them. E-bikes are parked in the SSM (figure 1), which facilitates access to campus buildings within the pedestrian island (about 300 m around it), while access to the micro-exchanger is by e-bikes, either (a) from one's own home, (b) or from a parking lot located in the peripheral area of urban centers, or on the peripheral campus of the university itself. In this way, SSMs promote sustainable urban mobility, reducing GHG emissions and promoting a culture of efficiency in urban movements without emissions, thanks to ITC platforms and the shared use of infrastructure.

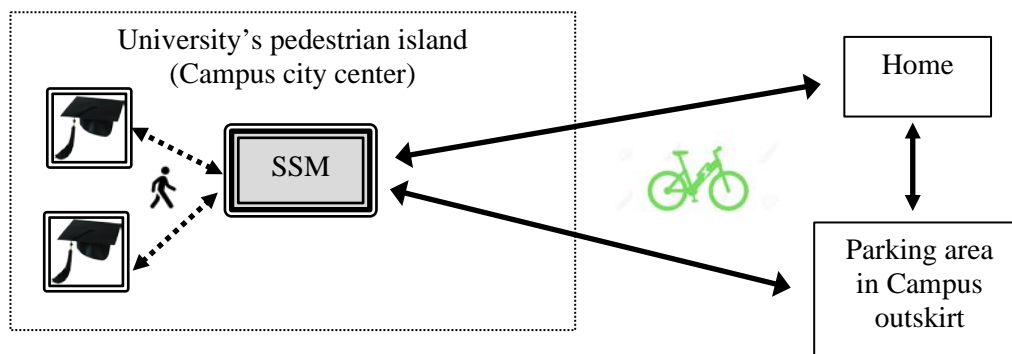

**Figure 1.** Scheme of sustainable mobility of the prototype in relation to the movements of users

The incorporation of photovoltaic solar energy collectors for the loading of e-bikes in the SSMs gives prominence to the emerging use of this means of transport where the electrical support can be an incentive for its use in topographies that alternate flat areas with areas of pending. The use of web platforms for the integrated management of the SSM also allows the creation of a user account that allows the reservation of space in the SSM to know the safe routes for movement in e-bikes and to track energy solar consumed.

## 2. Background

The issue of sustainable mobility in universities has been analyzed from the cost-benefit approach of using public transport [5]; although, the strategies point towards an increasing the proportion of staff / student commuting trips by walking and cycling [6]. In his study on the measures adapted by eight American university campuses to improve sustainability, Balsas [7] identifies as facilities sources for bikes: paths, lines and routes, spaces at parking racks and bicycle lockers. In the Politecnico di Milano (Italy), other strategies are increasing the number of bike shelters or installing charging stations for electric cars [8].

In Europe, many research and innovation activities improve the transition towards zero-emission transport, an example specialized in university transport is U-MOB LIFE [9]. The idea of a sustainable university campus is increasingly associated with that of a healthy university campus. By using e-bikes, significant CO<sub>2</sub> reductions can be obtained [10]. It is becoming an alternative to the car in urban areas, even it is preferred for commuting (home-work) and business (work related) trips rather than for recreational trips [11]. Unlike electric cars, they avoid the problems of traffic congestion and

traffic jams, and considerably reduce the need for parking and public space. In addition, the use of electric bicycles fosters a healthy campus, since its use allows carrying out an aerobic sports activity without sweating problems when arriving at the workplace, it has even been used in telerehabilitation programs [12]. The advantage of the electric bicycle is that it has support on hill climbs, which makes it a more attractive means than the conventional bicycle -especially over long distances-, with much lower economic acquisition costs than electric cars.

The future of e-mobility includes a wide net of smart charging stations and information systems [13]. Electric bicycle chargers are energy-autonomous infrastructures that can be located anywhere in the city, with the limitations of adequate sunlight. Many studies have developed smart charging of electric scooters from grid-connected photovoltaic-system [14], induction e-bike chargers [15]. In the development of these technologies on the University Campus, the prototype of a solar e-bike charging station in TU Delft [16] stands out [17]. However, the potential for design and expansion of uses and functions has yet to be exploited. Albertos Puebla et al. [4] concluded that it was necessary to increase the safety of the bicycles by means of a correct anchorage and the safety of the bicycle lanes, using closed and covered spaces.

SSM, as a smart e-charger, allows interaction with the user. Many universities have an environmental information website, e.g. the Autonomous University of Barcelona (Catalonia, Spain) offers a website / app that allows access routes to be established [18] and has a specific app for planning trips [19]. The smart e-bike monitoring system permits to view their own data and sharing on social media [20]. Many permanent station-sharing services are implemented in cities. For example, BiciMad (Madrid, Spain) has a mobile app, which allows checking e-bike availability, reporting incidents or managing payments [21]. Finally, the design and construction of the SSM constitute an educational innovation project in the development of final studies, since it is a meeting point for different degrees that work in a multidisciplinary and cooperative way to project and build equipment for the university community itself. The benefits that the live projects offer to students are: Management skills, Design skills, Problem-based learning and Autonomous learning [22].

### 3. Methodology and case study location

The prototype has been developed adapting the methodology for design science research process [23] to a transversal training that involves the integration of teams of students and researchers from four areas and systems: Architecture, Industrial Engineering, Computer Engineering and Telecommunications Engineering (table 1). The working methodology in the design of the prototype has been structured in three phases.

**Table 1.** Methodology scheme and interdisciplinary in relation to the four systems of SSM

	Conception and design	Manufacturing and assembly	Test	System
<b>Architecture</b>	Solar design	Assembly		(1)Architectonic and Urban
<b>Industrial Engineering</b>	Photovoltaic power system	Acquisition		(2)Energy management
<b>Computer Engineering</b>	Automation system Backend	Assembly Frontend		(3)Energy control
<b>Telecommunications Engineering</b>	of the management platform	of the management platform		(4)Platform management

The University of Malaga (UMA) as a case study is located in the city of Malaga (Spain). It is the sixth city with the largest population in Spain with 574,626 inhabitants in its municipality and around one million inhabitants in its metropolitan area. It is a public university with more than 40,000 students, 2,500 lecturers, and some 2000 administration staff. UMA occupies an area of 1,797,247 m<sup>2</sup>, and consists of 55 buildings. The UMA is structured in two university campuses: (a) the Teatinos Campus that integrates most of the academic centers and services and (b) the El Ejido Campus located next to the Historic Centre of the city and made up of only seven buildings. Within the El Ejido Campus, the SSM is located in the parking lot of the Faculty of Economic Sciences, where university users can park electric bicycles and, similar to electric cars, connect it to solar chargers while doing their activity university (figure 2). The percentage of daylight hours is 90.6%, the rest of the percentage being in the shade.

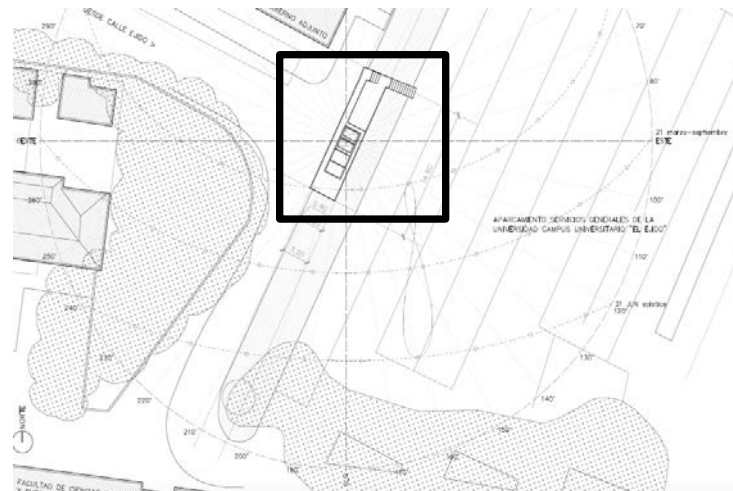

**Figure 2.** Location of SSM in El Ejido Campus

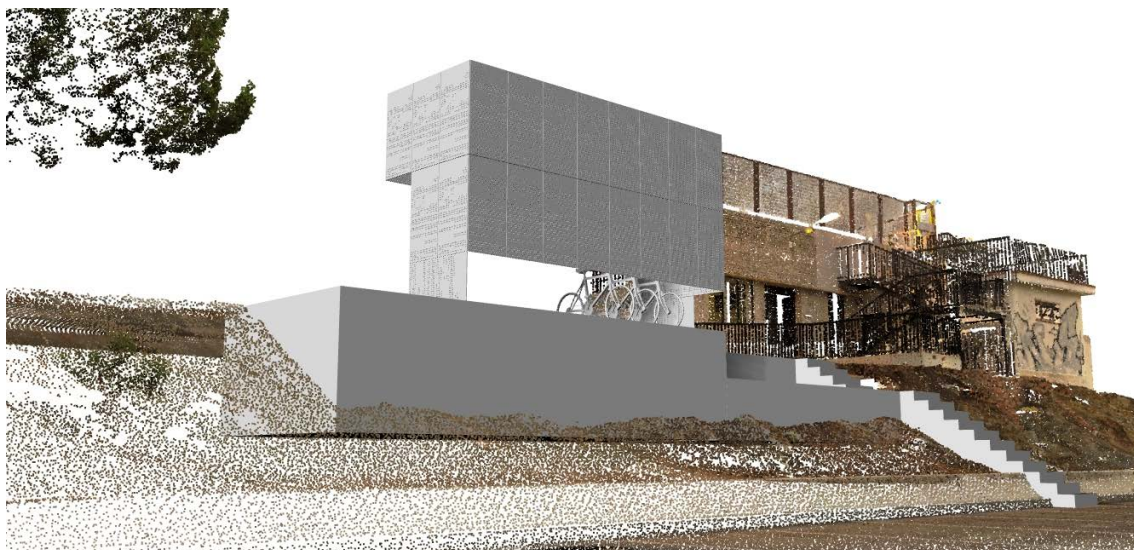

**Figure 3.** 3d rendering of the prototype implemented on a 3D laser scan of the site

#### 4. Results

SSM is the integration of four systems: (a) architectonic and urban system, (b) energy management system, (c) energy control system, and (d) platform management system.

#### 4.1. Architectonic and urban system

The main design features are: modularity, user friendliness and connectivity. The SSM has a modulated prismatic geometry design made up of a perforated wooden shell (Length: 6.0m x Width: 2.1m x Height: 3.5m). E-bikes are locked directly on a parallel bar. The FAB-LAB of the E.T.S Arquitectura [24] was used both in the design (with a digital 3D-scan of the workplace) and in the manufacturing of the prototype. The model responds especially to three aspects (figure 3):

(a) Solar collection. On the roof, the solar panels are placed with an inclination of 15°.

(b) Security. It is closed on three of its sides, which facilitates the protection and safety of the bikes while recharging, solving security issues against theft or deterioration.

(c) Landscape landmark. Added value is incorporated into the campus as landscape landmarks. In this case, a site with a strong inclination of the land was selected, which also required the corresponding conditioning work to be carried out.

#### 4.2. Energy management system

We use a hybrid PV system with grid support. The number of sensors required to supply 6 charging points for e-bikes requires a panel power of 500 W, which means 2 panels of 250 W Sunpower AC-310M / 60S. They are connected in parallel strings. Figure 4 shows a schematic of the electrical system. A maximum power point tracking (MPPT) converter (APS QS1) is used to extract power from the PV.

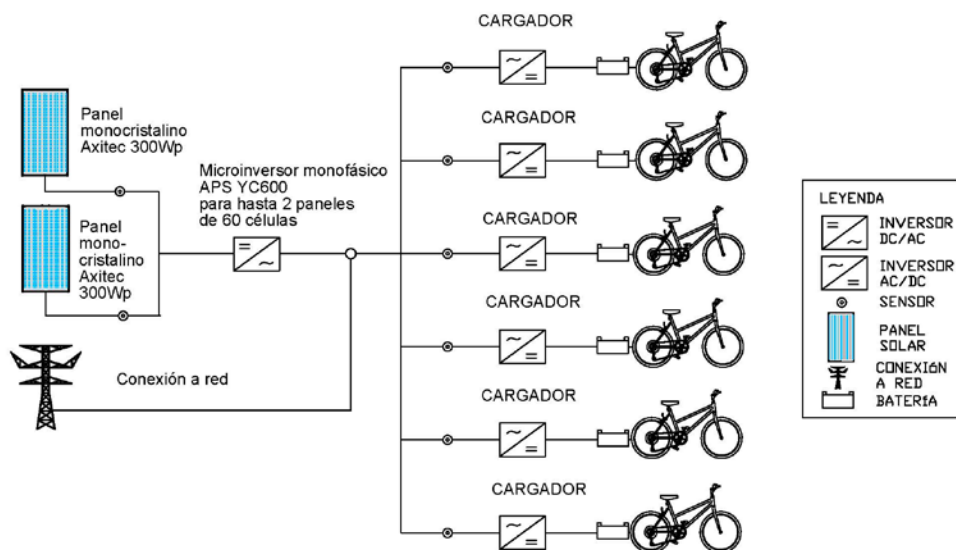

**Figure 4.** Hybrid PV system with grid support

#### 4.3. Energy control system

There have been developed a printed circuit board for the module to manage the selection of an energy system (solar panel or energy). This board includes Wi-Fi communications to connect with the cloud server (see figure 5 and table 2). The 230V AC input supplies the arduino board with a 5V output adapter and also supplies electrical power to the electric vehicle charger in case there is not enough current from the solar panels. In addition, it is controlled with an ACS712 current sensor to control and monitor the amount of energy coming from the network that is used. The input of the solar panels is regulated in the mechanism of the plates; therefore, there is no need for an additional fuse between this input and the arduino board. This input is monitored with another current sensor. Both sensors send data to the arduino board:

**Table 2.** Elements and description of the energy control system

Element	Description
[A] Arduino RoboDyn Mega 2560 Rev 3 board + Wi-Fi ESP8266 module	
[B] Relay Module SRD-05VDC-5L-C	Two-channel relay that controls the circulation of electrical current and is responsible for activating solar energy or, if this energy is insufficient, the energy input from the electrical network will be activated.
[C] ACS712 sensors	When one or the other channel is activated, the board will begin to count the amount of electrical energy and the type of energy used
[D] LCD screen	Displays real-time data from the Arduino board
[E] 1 channel relays SRD-05VDC-5L-C	Manages the activation or deactivation of the charging point of each e-bike by using the programmable board
[F] ACS712 sensors	They are current sensors that are placed interrupting the electrical line. As input, it has V and Earth, and allows the continuation of the line through two auxiliary pins

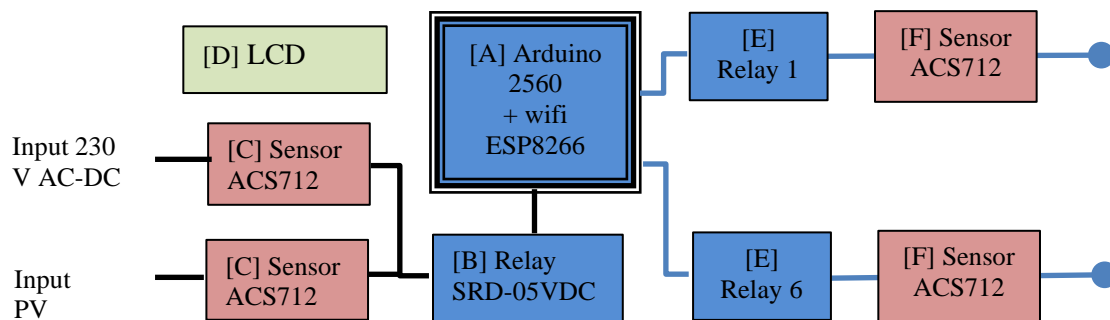

**Figure 5.** Energy control system scheme according to table 2

(a) If the input of the solar panels is greater than or equal to the minimum established by the equipment, the switch will let the current of the solar panels pass through and not that of the electrical grid. It will begin to count the time that this input is working to monitor how long renewable energy is being used.

(b) If the input of the solar panels is less than the minimum established by the equipment, the switch will let the current from the electrical network pass and not that of the solar panels. It will start to count the time that this input is working to monitor how long the energy from the electrical network is being used.

#### 4.4. Platform management system

The platform architecture (Figure 6) has a server located in the UMA, which manages the data internally through the Django Rest Framework and is related to the different components that we can divide into two groups: (a) external devices (web platform and mobile application) and (b) the internal devices (database and the arduino). For external devices, HTML, CSS, JavaScript is used in the web

platform and Android Studio for the app. While the internal database is used MySQL and is the one that stores (a) the information of users, reserves and energy consumption and production.

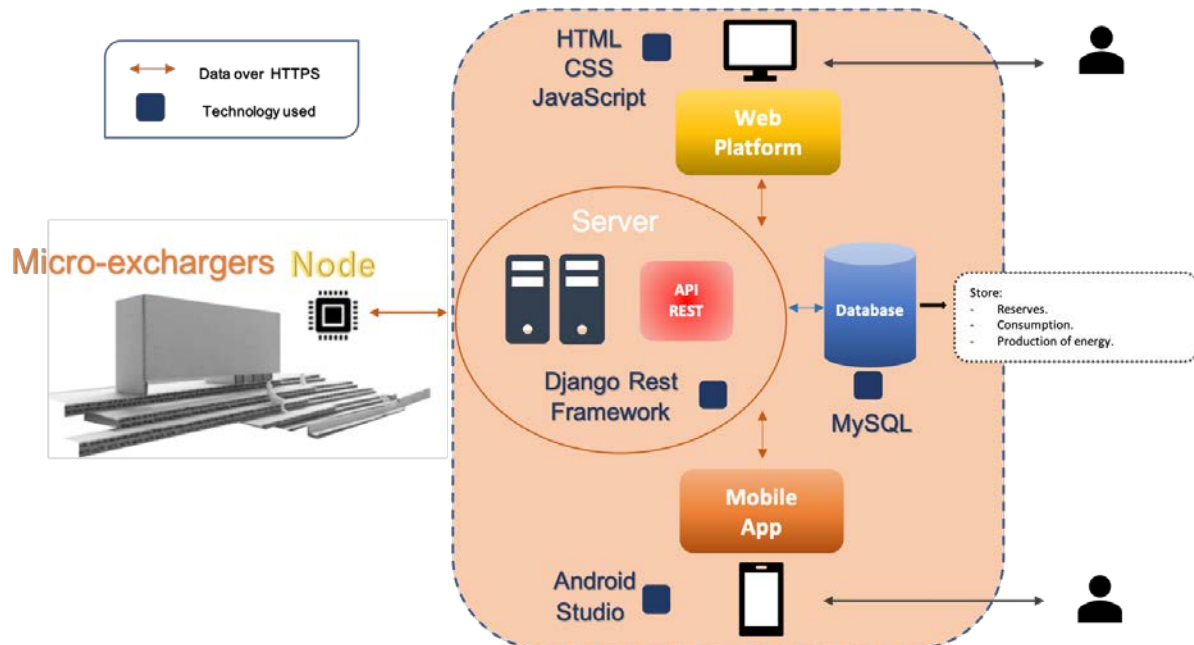

**Figure 6.** Management platform architecture

The management platform has a web page and app format where it provides two services (figure 7):

- Public information services: (1) Location of micro-exchangers and occupation status and (2) Mapping services for sustainable mobility.
- Personal services of the user's account. This constitutes a novelty in university campus mobility policies. Each identified user will have their own account in which they can manage the reservation of use of the e-bike. In this way, it is possible to have the user's mobility history, relevant information for mobility plans, as well as propose point programs for the use of the bicycle.

In both cases, from the home page, an explanation of the project is made and the location of the SSM is indicated. From here begins:

- User login and, where appropriate, creation of an account on the platform
- Reserves. This screen shows, on the one hand, the reservations already made (from a date with time to the same day with an end time) with the number of the reserved charger, and on the other hand, the reservation form (date and hours of reservation). The registered user can cancel the reservations made.
- Usage statistics. On the one hand, general usage statistics are shown in relation to the number of reserves (total and per month), consumption (month and total) and photovoltaic energy produced (total and month). On the other hand, the user's particular statistics appear in relation to reservations (total and last), consumption (average, maximum, minimum and total).
- Maps of quiet roads. The platform identifies and maps the quiet routes between the two university campuses (see figure 2 for El Ejido and Teatinos Campus connection) and identifies the possibilities of linking the bicycle with other public transport. The website offers an environmental information system where bicycle infrastructure (bicycle parking areas), bus stops, taxi stops, metro stops, and bicycle stops are geo-located.



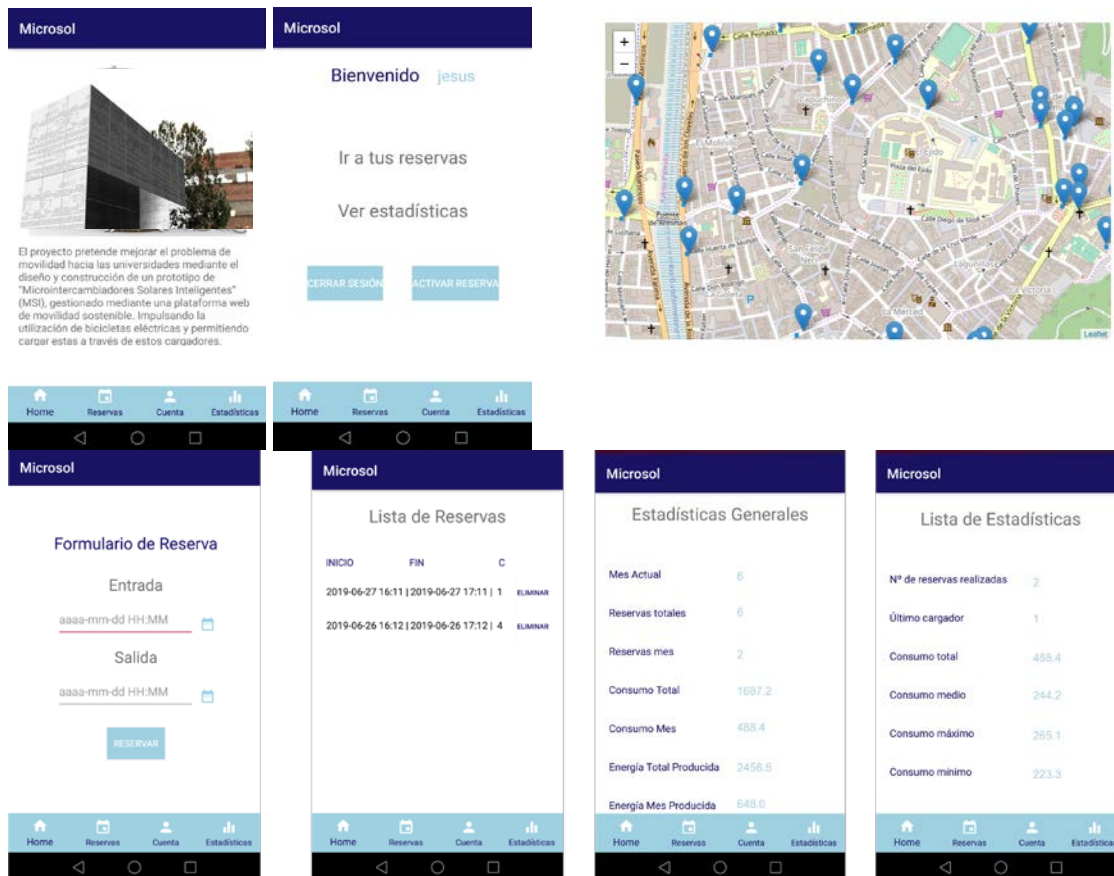

**Figure 7.** App of SSM: (above) main page personal account, (bottom) booking form and statistics. The web / app also provides a public transport map

**Table 3.** Improvements introduced by the prototype in relation to the objectives of the Smart Campus of the UMA

Smart Campus objectives	SSM prototype
Control and reduction of emissions, energy and water	SSM encourages the use of e-bike and public transport, reducing the use of non-electric cars and motorcycles
Improvement of mobility and use of efficient transport	The creation of an information platform to access the campus
Health and well-being of the university community	The promotion of the use of the electric bicycle implies the development of a healthy sport activity in the mobility of the university community
Use of Information Technology and Communications (ICT)	It offers more advanced management and information platform as it incorporates the concept of quiet streets.
Consolidation of creative public spaces and sustainable landscapes	It improves in the design of spaces that are usually arid and monotonous.
Promote and carry out research, teaching and innovation in sustainability	The project proposes a collaborative methodology to apply in master degree projects, especially in Architecture and Engineering with the development of experimental and live prototypes [22].

### 5. Conclusions

On table 3, we compare the main contributions of the SSM with the sustainability objectives of the UMA. The SSM is a comprehensive model that incorporates a modular design that promotes storage

security, a solar energy collection system, controlled by a web platform that allows managing reserves and accounting for the energy produced and the rental time of users. The MSI can alleviate parking and congestion problems at the El Ejido Campus since it can double the number of places (1 car place = 2 e-bike places). With the use of the MSI, no shower-changing rooms are required and the use of quiet streets can reduce the need to increase the construction of bike lines, thus, improving the campus policies analyzed by Balsas [7]. The use of this system can be exported to any type of company or public administration. It can also be used in neighborhoods, and be managed by neighborhood associations, with the advantage of implementing a sharing system. To sum up, SME contributes to creating an electric bike parking management system, which can help to shift the current mobility model in the university pedestrian island. More precisely, there has been developed the concept and general design of the modules, the foundations of the control system and the deep analysis of the energy management.

### Acknowledgment

This work was supported by the I Smart-Campus Plan of University of Malaga [project Microsol].

### References

- [1] Crue. *Declaración sobre la política de movilidad y accesibilidad en las universidades españolas*. [Online] 2011 [Accessed 22. 01. 2020] Available at: [http://www.crue.org/Sostenibilidad/CADEP/Documents/Documentos/5.DECLARACION\\_POLITICA%0A\\_MOVILIDAD\\_Y\\_ACCESIBILIDAD\\_UNIVERSIDADES.pdf](http://www.crue.org/Sostenibilidad/CADEP/Documents/Documentos/5.DECLARACION_POLITICA%0A_MOVILIDAD_Y_ACCESIBILIDAD_UNIVERSIDADES.pdf) (in Spanish).
- [2] J. L. de Las Rivas Sanz, F. I. Escudero, and J. L. Lalana Soto, “Campus Universitario de Valladolid: Integración urbana y movilidad”, *Bitacora Urbano Territorial*, vol. 18(1), pp. 139–156, 2011 (in Spanish).
- [3] Ò. Saladié, and J. Jurado, “La movilidad en el Campus Vila-seca de la URV: propuestas para una movilidad más sostenible”, *Investigaciones Geográficas*, vol. 64, pp. 163-182, 2015 (in Spanish).
- [4] J. Albertos Puebla, M. Pitarch Garrido, J. Noguera Tur, and J. Salom Carrasco, *Los hábitos de movilidad en la Universitat de València, 2005-6: problemas de acceso a los campus y sostenibilidad*. Valencia: Publicacions de la Universitat de València. 2007 (in Spanish).
- [5] P. K. Katuri, and K. S. Rao, “A Study on Operational Efficiency Enhancement of University Transport System with Special Reference to Vignana University, Guntur, Andhra Pradesh”, *Journal of Supply Chain Management Systems*, vol. 5(2), pp. 56–66, 2016.
- [6] A. Atherton, and D. Giurco, “Campus sustainability: Climate change, transport and paper reduction”, *International Journal of Sustainability in Higher Education*, vol. 12(3), pp. 269-279, 2011.
- [7] C. J. Balsas, “Sustainable transportation planning on college campuses”, *Transport Policy*, vol. 10(1), pp. 35–49, 2003.
- [8] G. Messori, E. Morello, E. Perotto, F. Infussi, G. Mondini, E. Faroldi, S. Tolentino, and M. Ugolini, “Mobility management at Politecnico di Milano: New infrastructures and behavioural change”. *IOP Conference Series: Earth and Environmental Science*. 2019.
- [9] Europe Network for Sustainable Mobility at University. [Online] 2016 [Accessed 22. 01. 2020] Available at: <https://u-mob.eu/en/project>
- [10] L. Winslott Hiselius, and Å. Svensson, “E-bike use in Sweden – CO2 effects due to modal change and municipal promotion strategies”, *Journal of Cleaner Production*, vol. 141, pp. 818–824, 2017.
- [11] A. J. Lopez, P. Astegiano, S. Gautama, D. Ochoa, C. M. J. Tampère, and C. Beckx, C., “Unveiling e-bike potential for commuting trips from GPS traces”, *ISPRS International Journal of Geo-Information*, vol. 6(7), 2017.
- [12] P. Mayr, M. Falgenhauer, R. Modre-Osprian, P. Hofmann, H. Traninger, M. Rath, and G. Schreier, HEALTHeBIKES-Smart E-Bike prototype for controlled exercise in

- Telerehabilitation programs. *Studies in Health Technology and Informatics*, vol. 248, pp. 307–313, 2018.
- [13] B. Kirpes, P. Danner, R. Basmadjian, H. de Meer, and C. Becker, “E-Mobility Systems Architecture: a model-based framework for managing complexity and interoperability”, *Energy Informatics*, vol. 2(1), 2019.
- [14] S. Mesentean, W. Feucht, H. G. Kula, and H. Frank, “Smart charging of electric scooters for home to work and home to education transports from grid connected photovoltaic-systems”, *2010 IEEE International Energy Conference and Exhibition, EnergyCon 2010*, pp. 73–78, 2010.
- [15] L. Celentano, D. Iannuzzi, and L. Rubino. “Detailed continuous and discrete-time models and experimental validation to design a power charging station for e-bike clever mobility”, *Electric Power Systems Research*, vol. 147, pp. 115–132, 2017.
- [16] Solar Powered Bikes, TU Delft Solar Powered eBike Station [Online] 2015 [Accessed 22. 01. 2020] Available at: <http://solarpoweredbikes.tudelft.nl>.
- [17] G. R. Chandra Mouli, P. van Vanduijsen, T. Velzeboer, G. Ganesan Nair, Y. Zhao, O. Isabella and M. Zeman, “Solar Powered E-Bike Charging Station with AC, DC and Contactless Charging”, *2018 20th European Conference on Power Electronics and Applications, EPE 2018 ECCE Europe*, 2018.
- [18] UAB, Mobility and transportation, Autonomous University of Barcelona [Online] 2020 [Accessed 22. 01. 2020] Available at: <http://www.uab.cat/web/inicio-1273127135815.html>.
- [19] UAB - App&Town [Online] 2020 [Accessed 22. 01. 2020] Available at: <http://apptown.accessibilitat-transport.uab.cat/?setLng=es>.
- [20] C. Kiefer, and F. Behrendt, “Smart e-bike monitoring system: Real-time open source and open hardware GPS assistance and sensor data for electrically-assisted bicycles”, *IET Intelligent Transport Systems*, vol. 10(2), pp. 79–88, 2016.
- [21] BiciMAD, Bonopark SL [Online] 2014 [Accessed 22. 01. 2020] Available at: <https://www.bicimad.com>.
- [22] C. M. Rodriguez, “A method for experiential learning and significant learning in architectural education via live projects”, *Arts and Humanities in Higher Education*, vol. 17(3), pp. 279–304, 2018.
- [23] K. Peffers, T. Tuunanen, M. A. Rothenberger, and S. Chatterjee, “A design science research methodology for information systems research”, *Journal of Management Information Systems*, vol. 24(3), pp. 45–77. 2007.
- [24] UMA, Laboratory of Advanced Experimental Architecture and New Technologies, University of Malaga [Online] 2016 [Accessed 22. 01. 2020] Available at: <https://www.uma.es/eamtechlab/info/120818/mica>.